

classic, prestige & define

ALUMINIUM WINDOW, DOOR AND ROOF SYSTEMS



WINDOWS, DOORS & BIFOLDS



Pure White



White Gloss



Cream



Agate Grey



Squirrel Grey



Anthracite Grey



Chocolate Brown



Jet Black



Pastel Turquoise



Mid Bronze Metallic Effect



Black Metallic Effect



Silver Metallic Effect

SI ROOF LANTERN



Pure White



Jet Black



Anthracite Grey

classic, prestige & define

high performance aluminium systems

THINKING DIFFERENTLY

The ultra-slim **Classic** system is an ideal replacement for traditional steel windows and doors or ideal for creating a modern, minimalist STYLE for renovations and extensions.

The chamfered exterior of the **define** window and door - another Whiteline Exclusive - is a variation on original steel windows but also replicates slim timber designs.

Prestige offers a wide range of high performance options in terms of glazing configurations including 44mm triple glazing to reduce unwanted noise whilst offering a 'U-Value' of just 1.0.





slimmer
frame,
more light,
wider view

classic windows

ultra-slim and secure window system



ultra-slim
appearance





classic windows

ultra-slim and secure window system





**Stepped sash,
Flush frame**

**Stepped sash,
Standard frame**

**Contemporary sash,
Flush frame**

**Contemporary sash,
Standard frame**



The ultra slim 59mm sightlines maximise incoming light.

Our patented construction method, using threaded screws to bind corners tightly together in perfect unison creates perfect run through mitres on internal joints, doing away with the unsightly junctions of square cut beads seen on ordinary aluminium windows.

We've also eliminated the stepping of misaligned corners, allowing each Sheerline window to be individually hand tuned to perfection. Leaving you with the perfect balance of understated refinement and exacting quality standards.

classic beadless

ultra-slim beadless wrap-around glazing

Flat 25mm
astragal bar



DOUBLE GLAZED
U-VALUE



DOUBLE GLAZED
WER

Built around an innovative Thermlock® multi-chamber thermal break, our windows use a patented construction method that offers unsurpassed levels of security. Creating windows that are strong and durable, yet with slim frames that maximise the light flooding into your home. Sheerline aluminium windows are also available in a wide range of colours, letting you express your home's character.



The clip-in glazing bead

classic beaded

the next evolution of this ultra slim system



Our Classic window has been developed further for customers who may prefer traditional glazing beads for glass installation.

The clip-in bead previously available on our Prestige system can now be used on these elegant slimline windows.

The use of a glazing bead enables the beaded system to be externally glazed to create an unequal sightline appearance which is particularly suited to the steel-framed industrial/art deco designs from the last century.



**DOUBLE GLAZED
U-VALUE**



**DOUBLE GLAZED
WER**



Our Classic HERITAGE door is designed to emulate steel window and door designs reaching back almost 200 years.

These original mid-1800's designs tended to have a square astragal bar glass layout but by the 1920's Art Deco period the window bars were horizontal which continued the Modernist architecture through to the 1960's. Capturing the aesthetics of steel doors, harmonising perfectly with our stepped-sash windows and matching the performance of modern aluminium doors and windows.



**HERITAGE
4-Bar Residential Door**
Single door
in Agate Grey



**HERITAGE
2-Bar Residential Door**
Single door
in Metallic Bronze



Monkey Tail
Lever/ Lever
Handle



classic HERITAGE

authentic steel door aesthetics



Noble
Lever/ Lever
Handle



Sculptured
Lever/ Lever
Handle



Architectural
Lever/ Lever
Handle



Heritage
Lever/ Lever
Handle



In addition to the standard Balmoral contemporary handle, we offer 3 traditional lever handles from the last two centuries. Although not from any particular time period, these traditional designs are well-suited to this stylish range of doors.

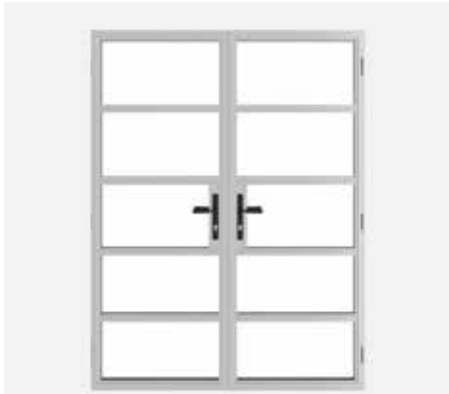

HERITAGE 4-Bar French Door
Double door
in Silver Metallic



HERITAGE 2-Bar French Door
Double door
in Cream



HERITAGE French Door
Double door
in Agate Grey



HERITAGE 4-Bar Residential Door
Single door
in Jet Black



HERITAGE 2-Bar Residential Door
Single door
in Pure White



HERITAGE Residential Door
Diamond-lead single door
in Anthracite Grey

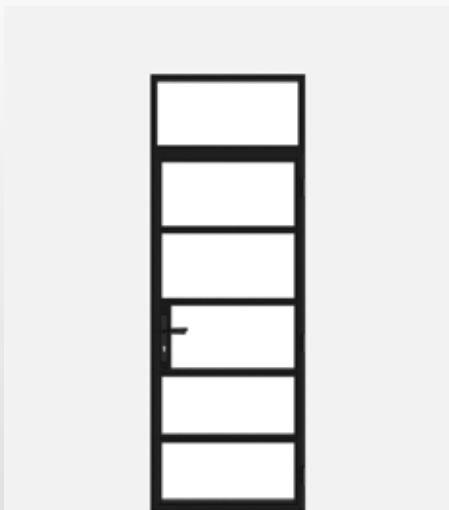

HERITAGE 4-Bar Residential Door with Toplight**
Single door
in Black Metallic



HERITAGE 4-Bar Residential Door with Toplight**
Single door
in Turquoise

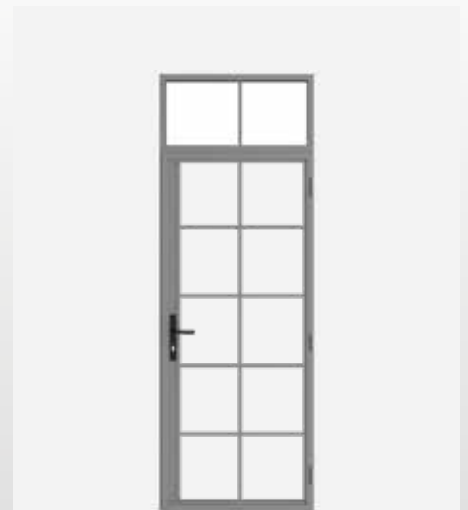

HERITAGE Residential Door with Toplight**
Square-lead single door
in Squirrel Grey

**** Toplight**

For outward opening door sashes, outerframes can be manufactured in one piece rather than as an additional casement

classic HERITAGE

authentic steel door aesthetics



HERITAGE French Door with matching Stepped-Sash French Window
Balanced handle double door design suits modern symmetrical tastes



Balmoral
Contemporary
Lever/ Lever
Handle



**Dummy
Transom**
Authentic structural
transom

With a stepped and flat 'contemporary' profile already, the Classic range already covers many architectural styles in Britain. We have now added a proper traditional timber 'puttyline' window and door style - this is define.



contemporary
flat sash

stepped
steel window inspired sash

classic define window

beaded exclusive from Whiteline



define
chamfered sash



UNIQUE FEATURE GROOVE



DOUBLE GLAZED
U-VALUE



DOUBLE GLAZED
WER

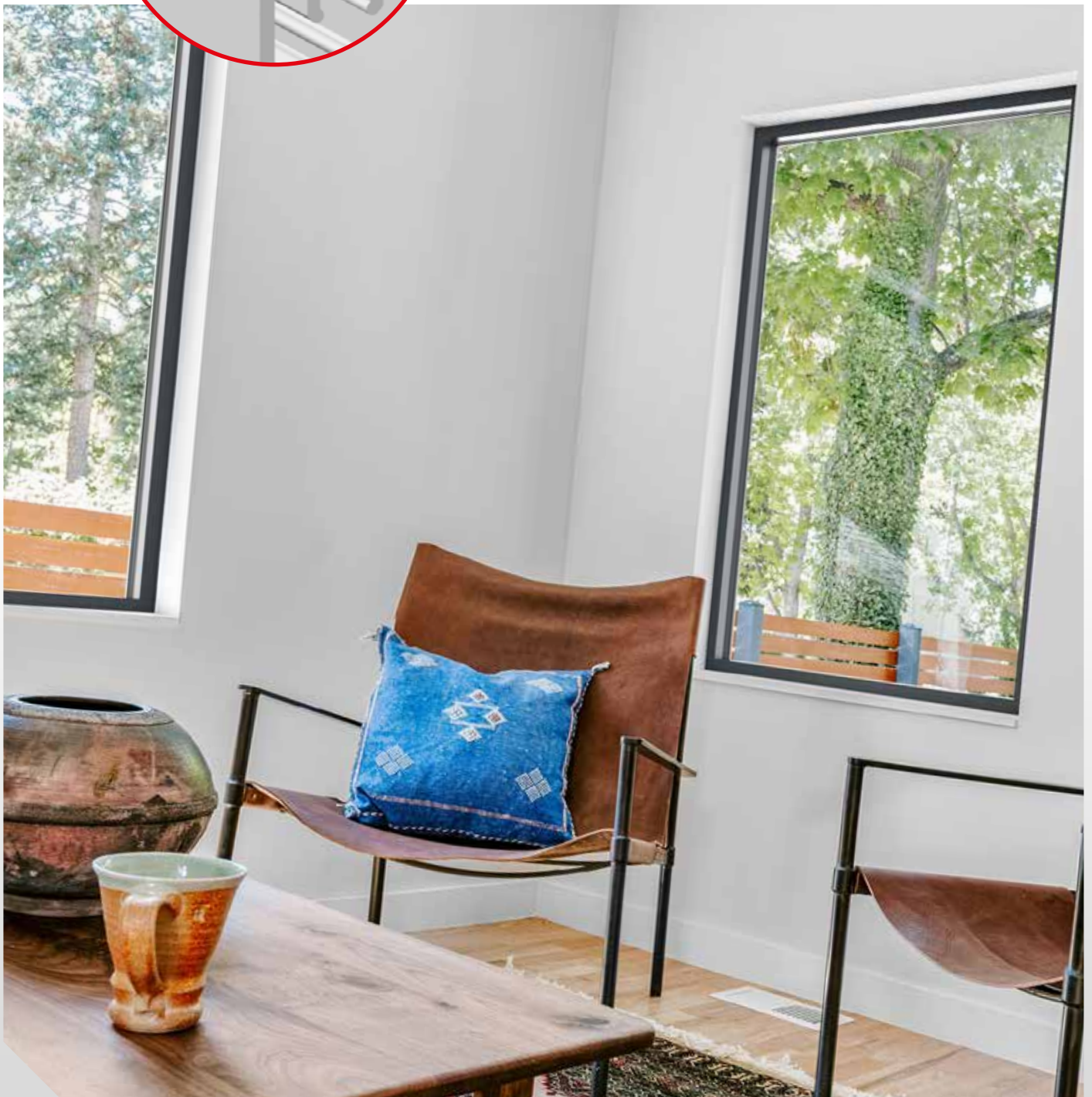

classic define window

beaded exclusive from Whiteline

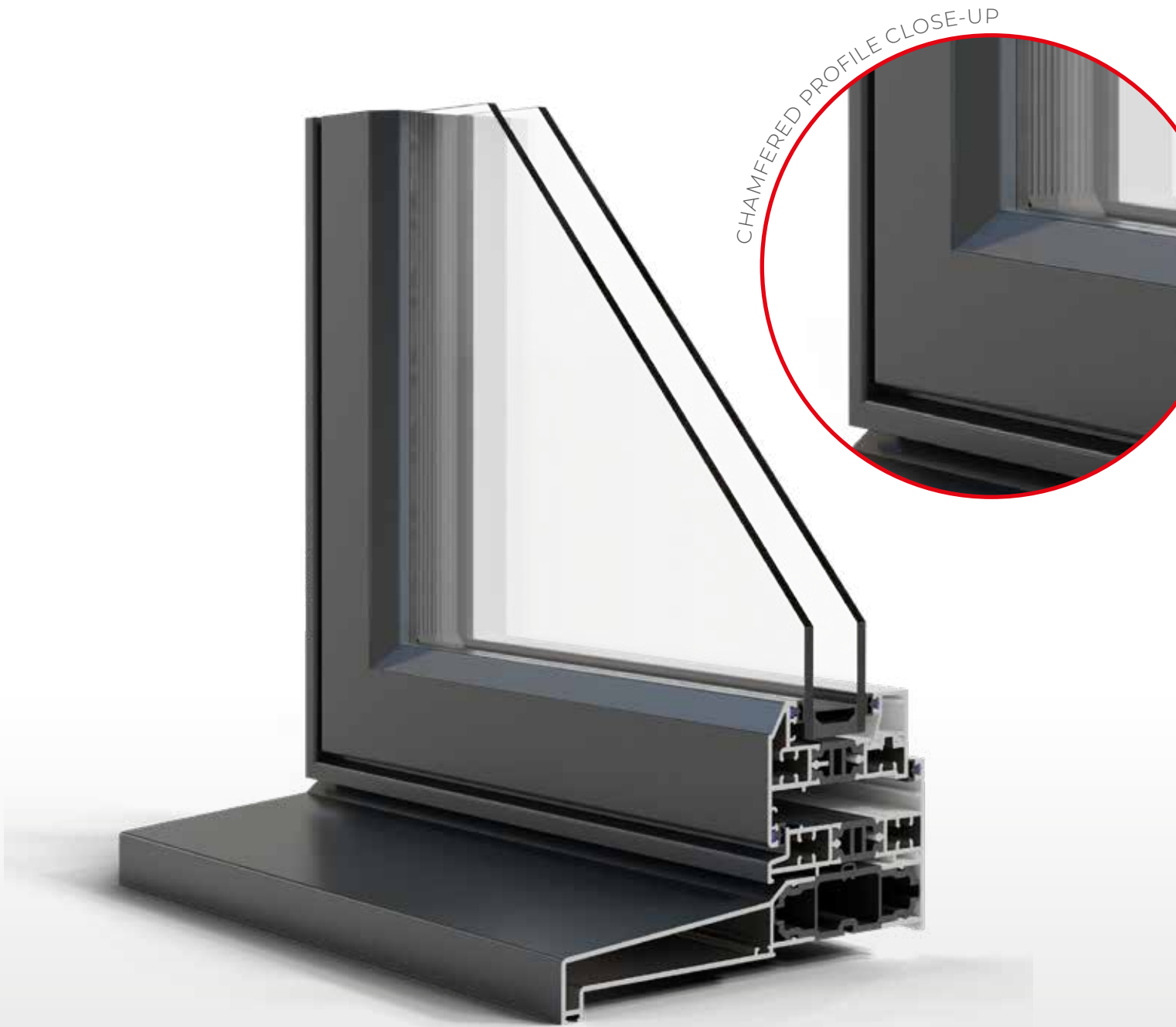

The Classic range already covers a 'flat', contemporary style as it does a 'stepped' steel-window appearance. Whiteline® have created a cross-generational design suited to contemporary and traditional property styles.

The clip-in bead previously available on our Prestige system can now be used on these

elegant slimline windows.

The use of a glazing bead enables the beaded system to be externally glazed to create an unequal sightline appearance which is particularly suited to the steel-framed industrial/art deco designs from the last century.



prestige windows & doors

high-performance window and door system



SIGHTLINES FROM 88mm



Our most thermally efficient 72/80mm system, accommodating the largest apertures, and available in the widest range of styles.

Prestige windows feature a full depth Eurogroove, giving you the maximum choice in hardware options.



**Stepped sash,
Flush frame**

**Contemporary sash,
Flush frame**

**Contemporary sash,
Standard frame**

prestige window

high performance casement window

Our patented construction method – using threaded screws to bind corners tightly together – helps eliminate misaligned corner issues that can occur on ordinary aluminium frames.

Allowing each window to be individually hand tuned to perfection. This innovative corner jointing method also does away with the need for crimping and specialised machinery and drastically reduces waste. Larger frames can also be assembled in situ if required.

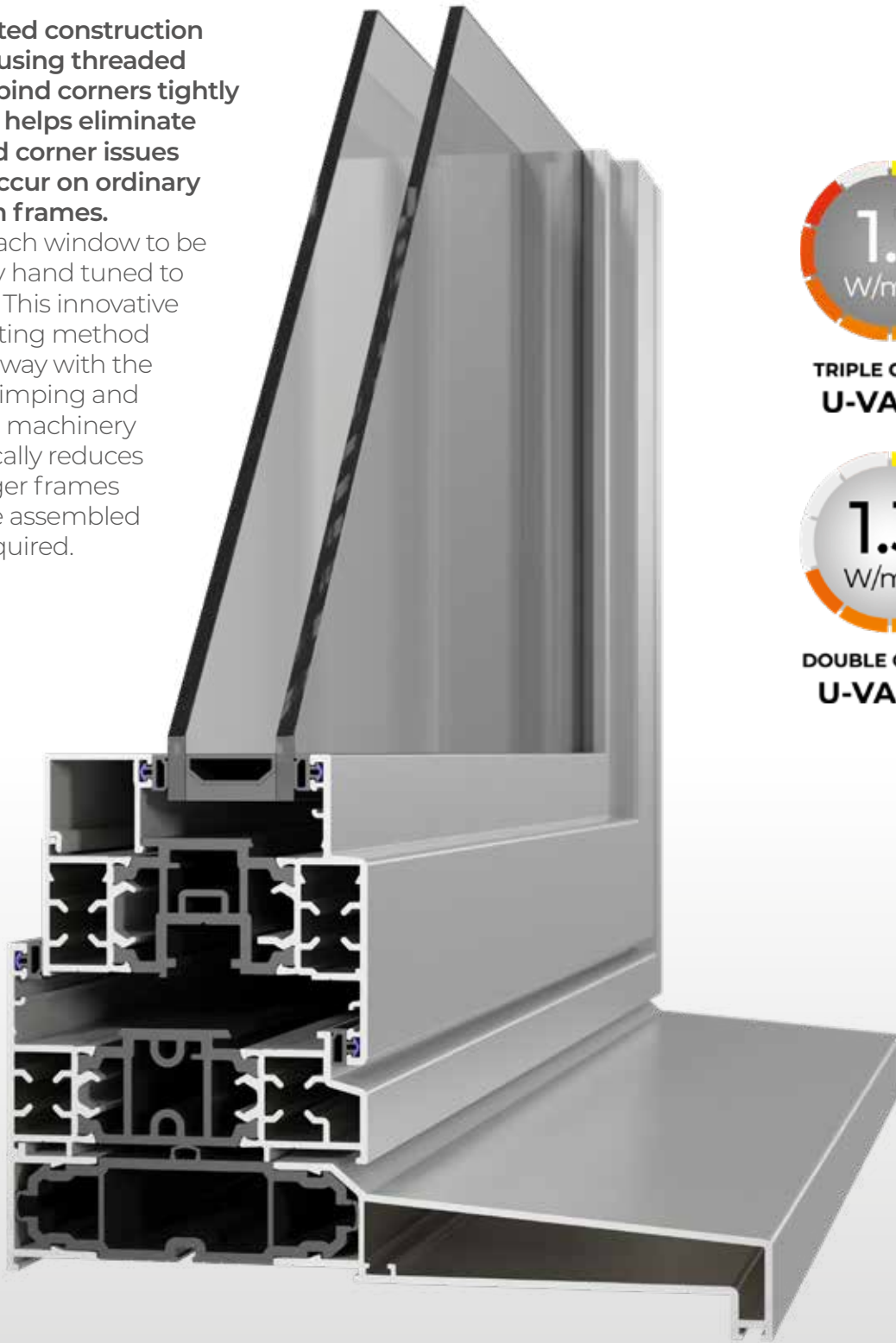

**TRIPLE GLAZED
U-VALUE**



**DOUBLE GLAZED
U-VALUE**

Casement, French and Tilt and Turn windows

Can accommodate the largest spans and biggest windows. 72mm front to back as standard, – in-line with the Classic flush profile width – allowing the systems to be joined. 80mm for Flush frames.



Tilt and Turn, as the name suggests, means that the inward opening window sash can be either tilted backwards for light ventilation or turned on its vertical hinge for a fully-opened window sash.

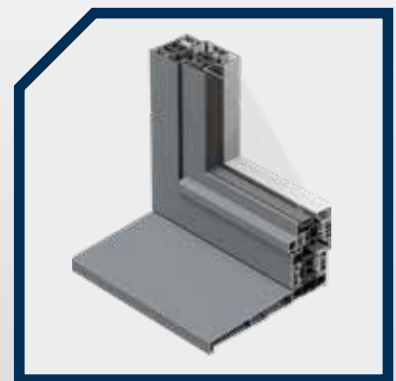
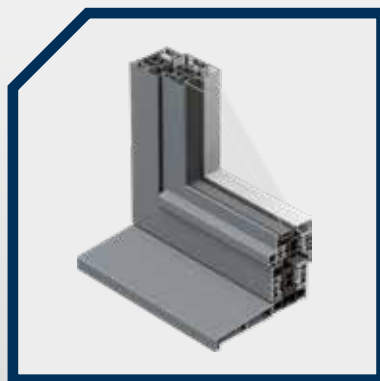
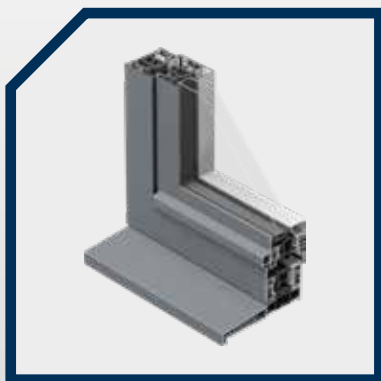

A choice of 3 depths of cill profile for the most demanding weathering requirements.

prestige tilt & turn window

for large opening casements and multi-storey applications



TRIPLE GLAZED
U-VALUE



DOUBLE GLAZED
U-VALUE



< **stepped sash** >

traditional steel window appearance

< **contemporary sash** >

modern flat appearance

The Prestige door range includes the flat, contemporary sash along with the stepped sash. This ensures a 'suited' appearance with our windows. Prestige can be configured as 'open-in' or 'open-out' doors to cover all possible applications along with being paired as French doors.

SIGHTLINES FROM 128mm

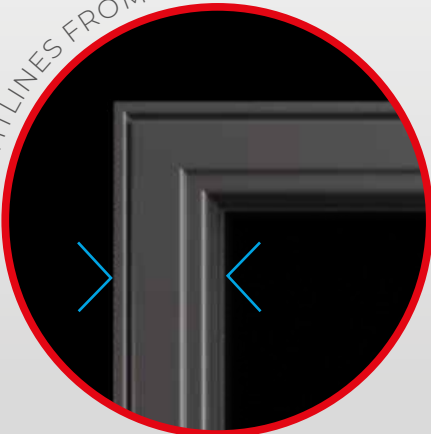

DOUBLE GLAZED

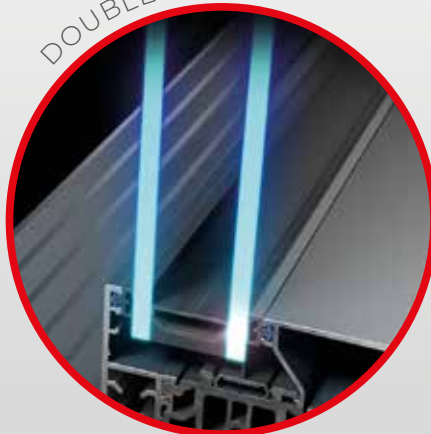

TRIPLE GLAZED

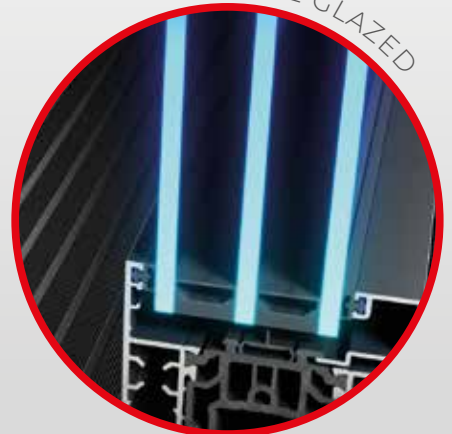

prestige define door

beaded exclusive from Whiteline

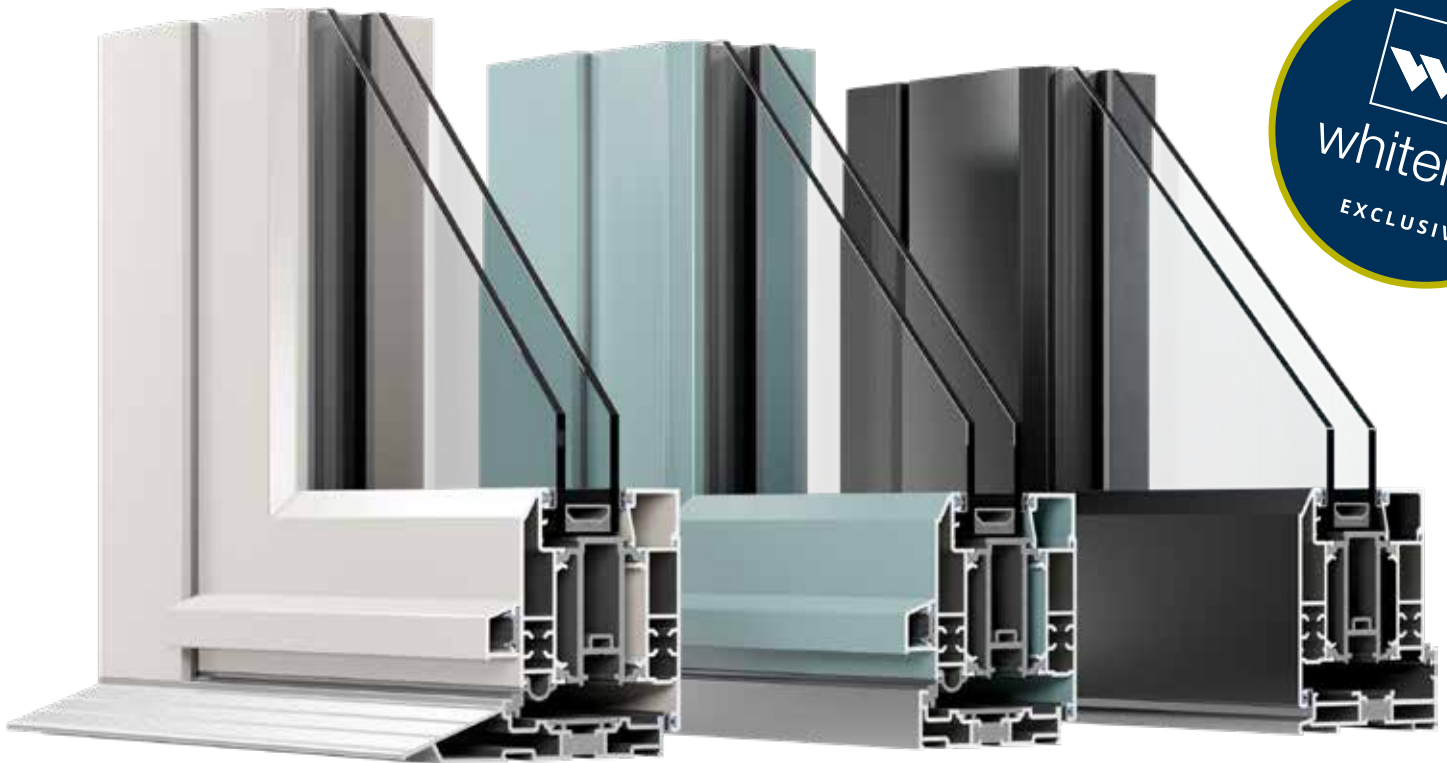

define sash



traditional chamfered timber window appearance



**TRIPLE GLAZED
U-VALUE**



**DOUBLE GLAZED
U-VALUE**

EXCLUSIVE PRESTIGE DEFINE MID-RAIL

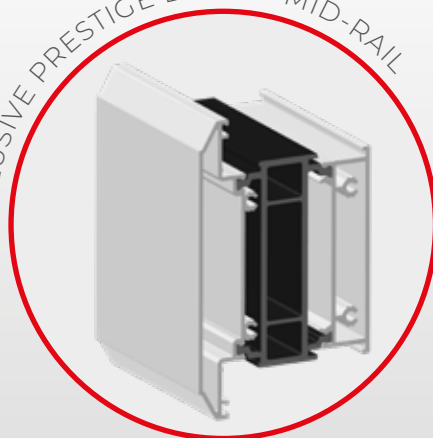

Our exclusive define profile is also available for the Prestige door - this ensures continuity of design across our casement doors and windows.

Again, the chamfered appearance makes them the perfect choice not just for 'new-build' but also for replacement windows. Replace original timber doors with an equally slim, strong, secure and energy efficient alternative not to mention the low maintenance and eco credentials of using aluminium.

SLIM INTERLOCK ONLY 52mm



STANDARD INTERLOCK ONLY 80mm



PATENTED SEAL ARRANGEMENT

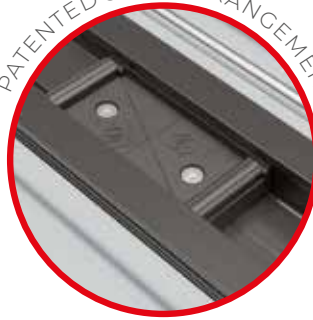

DUAL OR TRIPLE TRACK OPTION

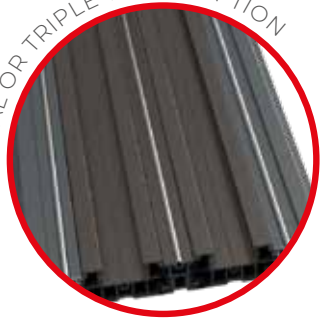

Designed to cover the widest range of requirements possible, from modest replacement projects to vast new build and extension requirements, the new Prestige Lift & Slide patio is designed to operate flawlessly at any size.

Running on stainless steel tracks and using specially modified high-performance running gear ensures doors glide smoothly during operation. These utilise bespoke Lift & Slide gearing based on a proven platform to ensure ultra smooth and reliable operation



Low threshold with ramp



Standard outer frame

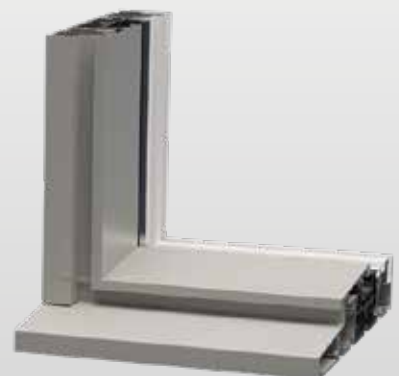

Standard outer frame with clip-on cill nose

prestige lift & slide doors

slim and secure sliding patio door



TRIPLE GLAZED
U-VALUE



DOUBLE GLAZED
U-VALUE

HIPCA GLOSS WHITE



PURE WHITE MATT



ANTHRACITE

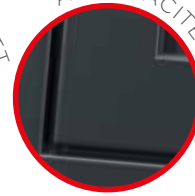

JET BLACK

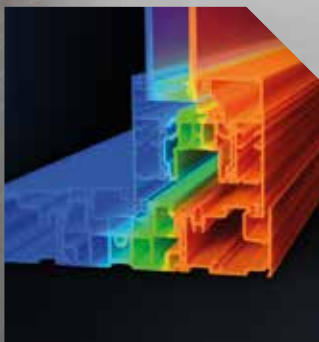
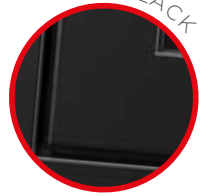

Thermlock® technol-
ogy

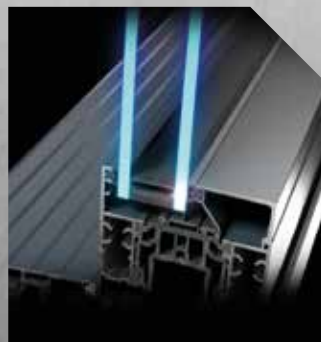

Double-glazed

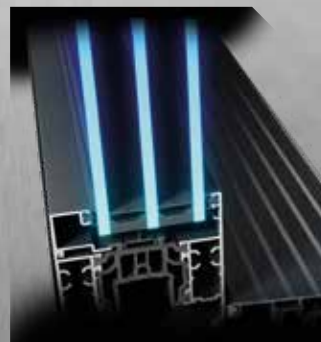

Triple-glazed



Prestige clip-in
glazing bead

stepped or
contemporary
profile
design



prestige bifold doors

beautifully balanced bifold doors





Slimline internal handles are elegant and unobtrusive



Custom designed single rollers eliminate the need for floating mullions



TRIPLE GLAZED
U-VALUE



DOUBLE GLAZED
U-VALUE



Prestige bi-folds enable you to open up and transform your home. Providing that all important flexibility to enjoy your indoor and outdoor space as one.

Combining the refined, architectural look of aluminium and the latest thermal and security technology, leaving you with beautifully balanced bi-folding doors. Bi-folding doors should maximise the light flooding into your home, and the enjoyment of your garden or

patio. Bringing an improved sense of space and creating panoramic views that can transform interiors. They also need to offer reliable operation, while keeping heating bills low, and would-be intruders out. That is why we have designed our Prestige bi-folds to offer you the perfect balance of refined looks, exceptional thermal performance and outstanding operation.

prestige bifold doors

slim and secure bifold patio door



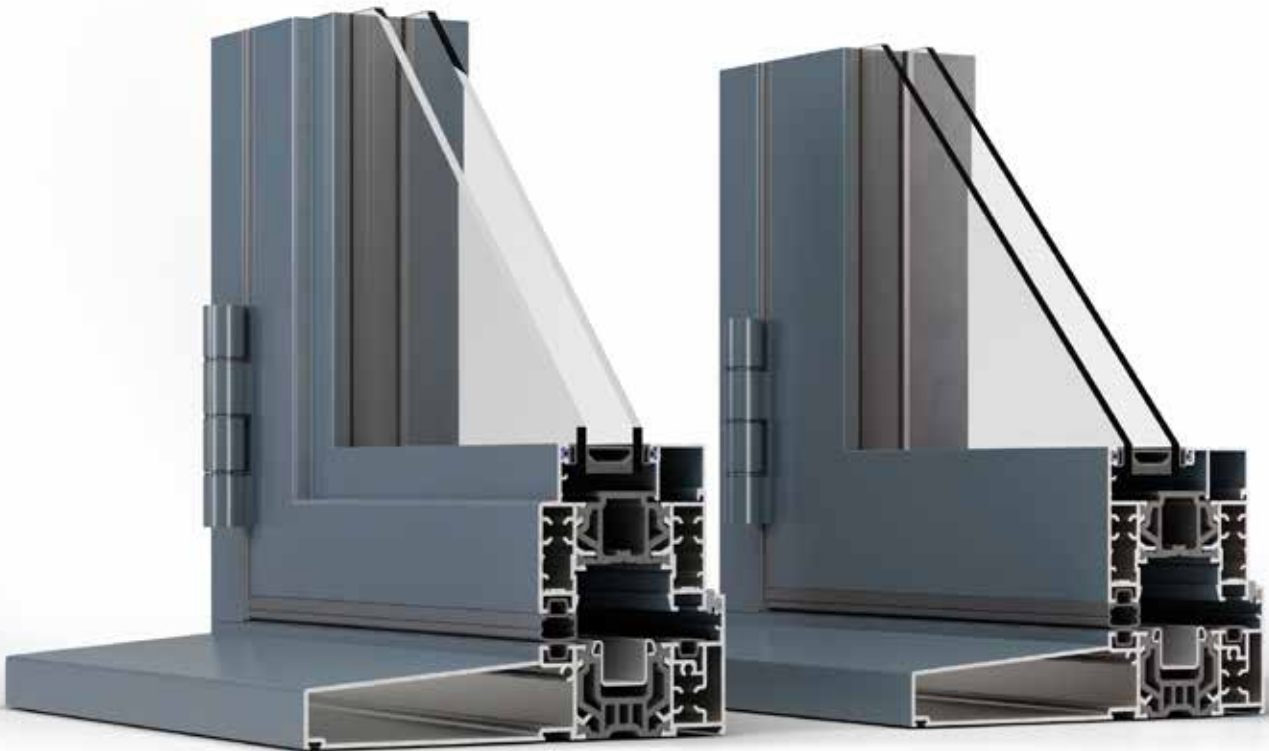

Stepped sash

Contemporary sash



BOTTOM ROLLER



DRAINAGE END CAP



TRIPLE GLAZED

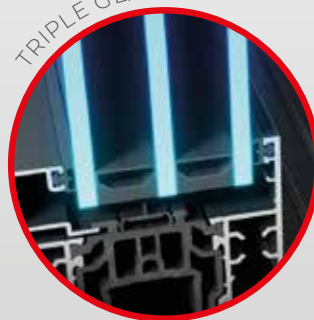

DOUBLE GLAZED

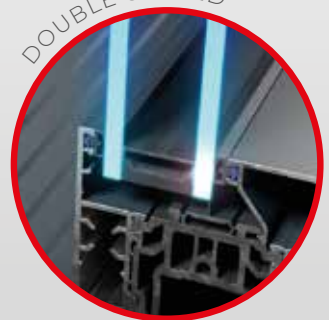

prestige bifold doors

slim and secure bifold patio door



Cill end cap



SECURE INTERLOCK SYSTEM



2-PIN SECURITY BOLT



FLUSH SASH AND FRAME



SLIMLINE SASH HANDLES



S1 lantern roof

slim and secure lantern roof



Sheerline lanterns are available in three standard powder coated colours, with the option of choosing a different colour for the interior to help you create the look that is perfect for your property.

Bespoke colours can also be ordered to accent, or match your particular project requirements.

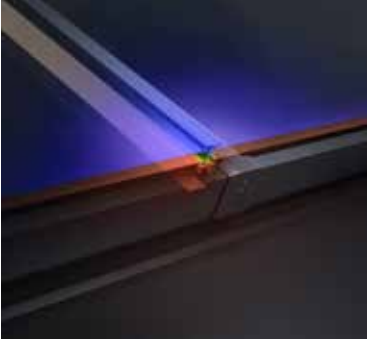

Thermlock® technology inside

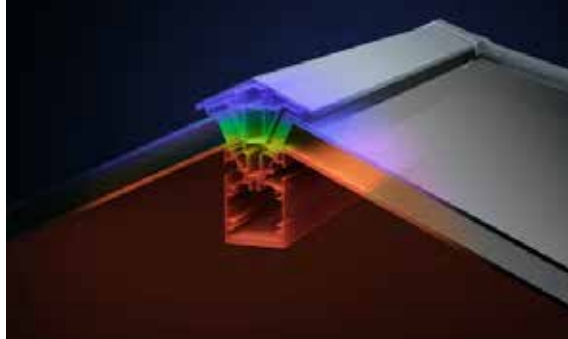

28mm glazing units with 1.0 Wm²K U-Value

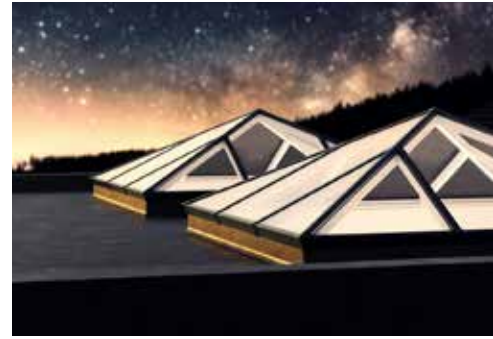

With great looks from every angle – due to our unique ultra low line aesthetics



Sheerline aluminium roof lanterns are available in a choice of 10 styles from square 'pyramid' designs to grander options suitable for larger 'orangery' style installations.

Maximum sizes up to 3.2m by an impressive 6m long, all set at a 25° pitch and all weather

rated for the whole of the UK*.

S1 lanterns also feature an integral LED light channel around the perimeter of the roof – giving you an easy way to add mood lighting and create the final touch of individuality for your interior.

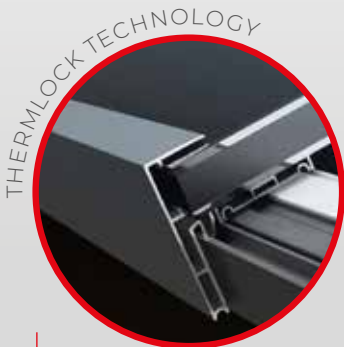

THERMLOCK TECHNOLOGY



DOUBLE GLAZED



TRIPLE GLAZED



SECURE INTERLOCK SYSTEM

S1 lantern roof

slim and secure lantern roof

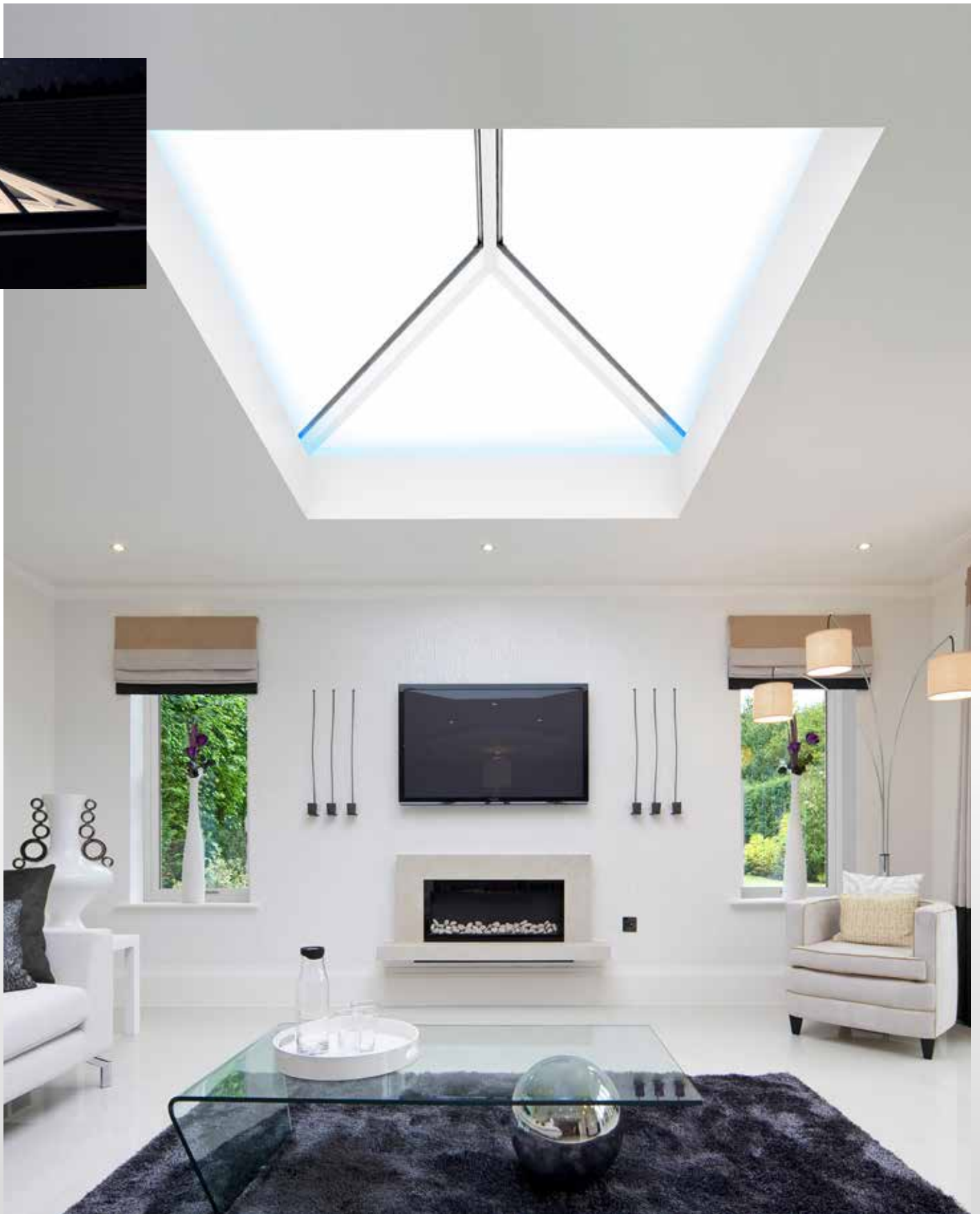

Unique construction

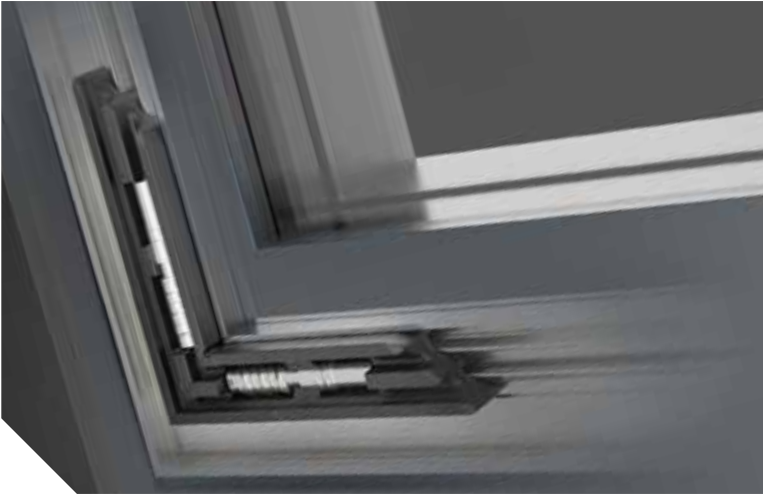

The patented construction method – using threaded screws to bind corners tightly together in perfect unison – creates perfect run through mitres on internal joints on **Classic Beadless windows**. This removes the stepping of misaligned corners, allowing each Sheerline window to be individually hand tuned to perfection. Leaving you with the perfect balance of understated refinement and exacting quality standards.

2 FRAMES, 3 SASHES, 6 COMBINATIONS



Stepped sash,
Flush frame

Stepped sash,
Standard frame

Contemporary sash,
Flush frame

Contemporary sash,
Standard frame

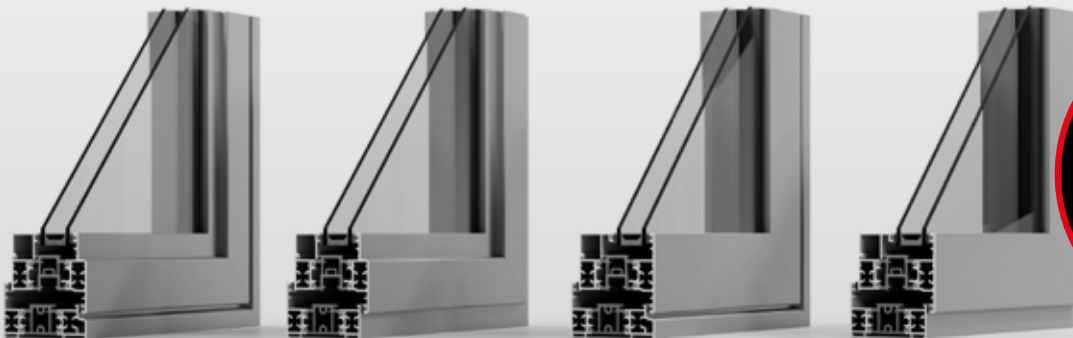

Stepped sash,
Flush frame

Stepped sash,
Standard frame

Contemporary sash,
Flush frame

Contemporary sash,
Standard frame

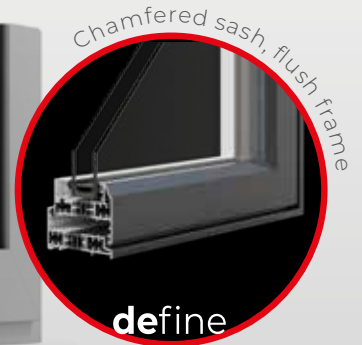

Chamfered sash, flush frame

define

window features

comparing individual characteristics of Classic, Prestige and define

Patented corner jointing method securely locks the glass within a completely sealed unit. Coupled with the high security multipoint locking and unique hinge protectors create unparalleled levels of security.

Classic BEADLESS

Innovative construction eliminates the need for separate glazing beads

Factory-glazed for speed and convenience

Equal sight-lines to create a balanced aesthetic

Classic BEADED

Clip-in bead, no gasketing on-site

Glass available loose or as an unglazed product

Run-through mitres on internal joints avoid junctions of square cut beads

Triple-glazing option on Contemporary sash

define

Unique chamfered sash with feature groove

Clip-in bead, no gasketing on-site

Glass available loose or as an unglazed product

Run-through mitres on internal joints avoid junctions of square cut beads

Prestige

Separate glazing beads

Glass available loose or as an unglazed product

Larger profile facilitates additional glazing options including triple-glazing on both sash styles

	Classic Beaded		Classic Beadless		define	Prestige
Sash type	Stepped	Contemporary	Stepped	Contemporary	Chamfered	All
Clip-in glazing beads	✓	✓	✗	✓	✓	✓
Sash & frame sightline	60.5mm	60.5mm	59mm	59mm	60.5mm	88mm
Contemporary sash	✓	✓	✓	✓	✗	✓
Stepped sash	✓	✓	✓	✓	✗	✓
Chamfered sash	✗	✗	✗	✗	✓	✗
Flush outer frame	72mm	72mm	72mm	72mm	72mm	80mm
Standard* outer frame	64mm	64mm	64mm	64mm	64mm	72mm
Energy rating	B	B	B	B	B	A
U-Value - double-glazed	1.5 Wm ² K	1.5 Wm ² K	1.5 Wm ² K	1.5 Wm ² K	1.5 Wm ² K	1.3 Wm ² K
U-Value - triple-glazed	✗	Untested	✗	Untested	✗	1.0 Wm ² K
Double-glazed Unit	28mm	28mm	28mm	28mm	28mm	28mm
Triple-glazed Unit	✗	36mm	✗	36mm	✗	44mm
PAS24: 2016 accredited	✓	✓	✓	✓	✓	✓
High Security** upgrade	Optional	Optional	Optional	Optional	Optional	Optional

* **Standard** outer frame creates a stormproof 'lipped' casement with all sash designs

** **High Security Upgrade** uses the 'Secured by Design' specification from Sheerline, but does not imply that Whiteline Manufacturing holds 'Secured by Design' accreditations for these particular products at the time of producing this brochure.

cross-sections of the classic and define window system

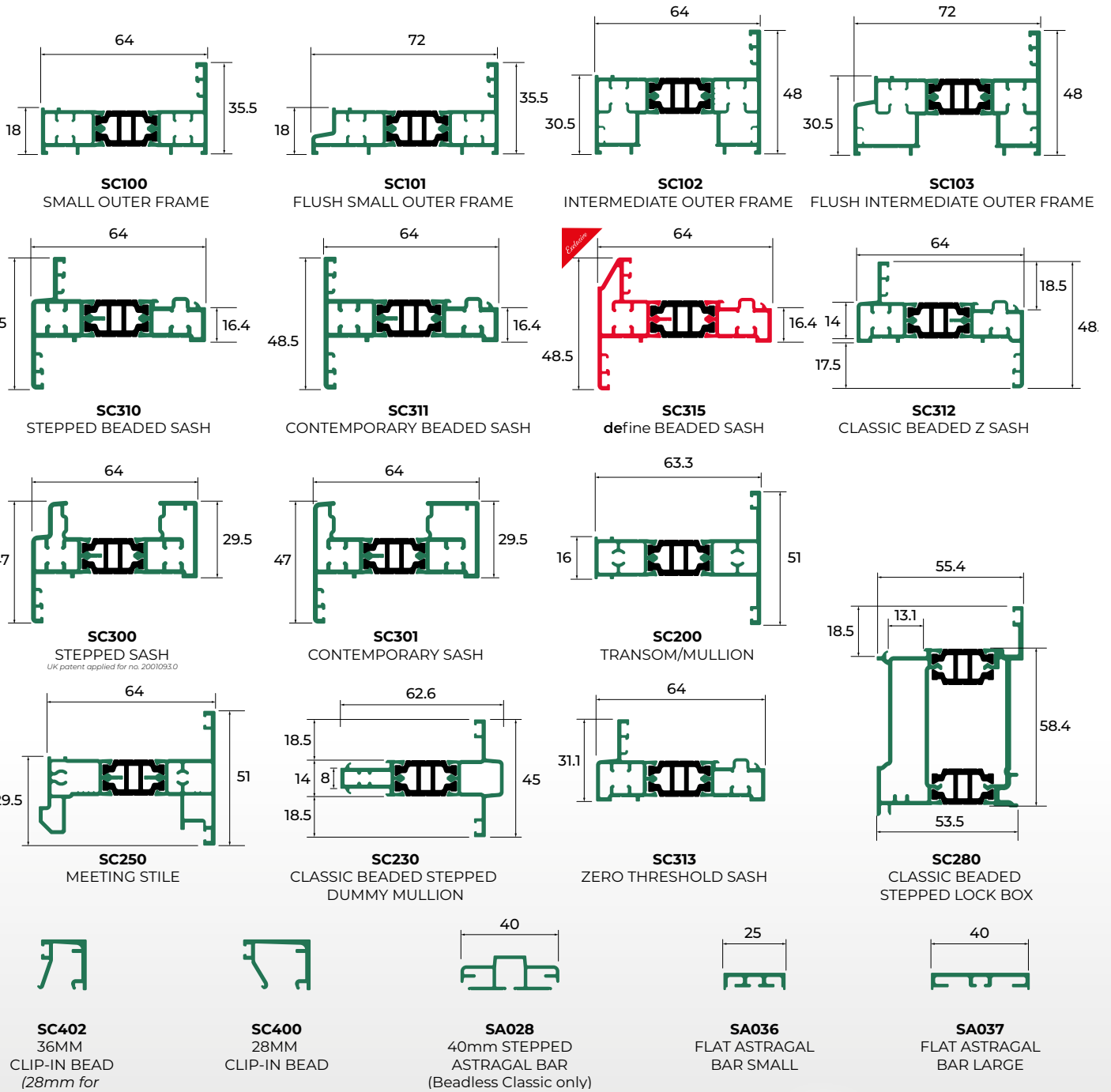

Exclusive

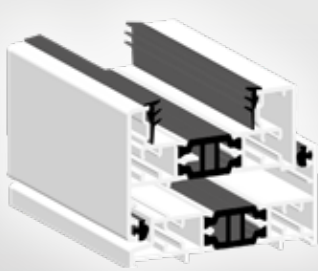

Contemporary sash,
Flush frame

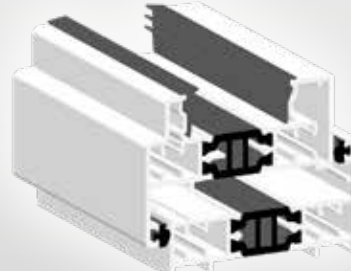

Stepped sash,
Standard frame

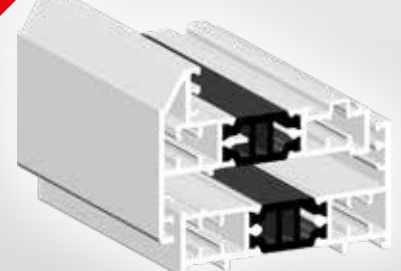

define sash,
Standard frame

profiles

cross-sections of the prestige window system

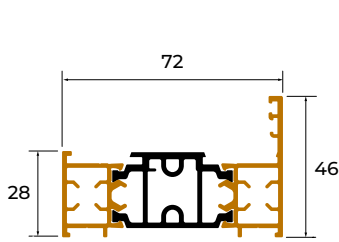

SP100
SMALL OUTER FRAME

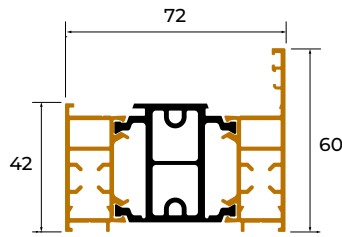

SP102
INTERMEDIATE OUTER FRAME

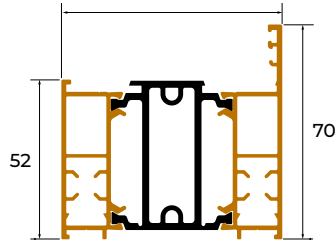

SP104
LARGE OUTER FRAME

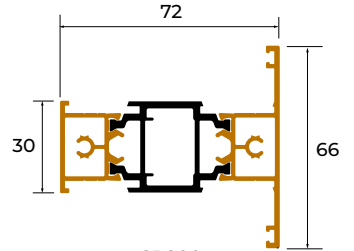

SP200
TRANSOM/MULLION

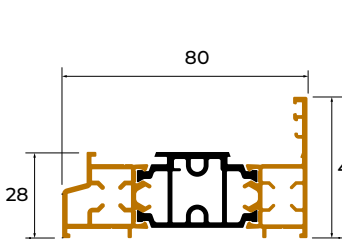

SP101
SMALL FLUSH OUTER FRAME

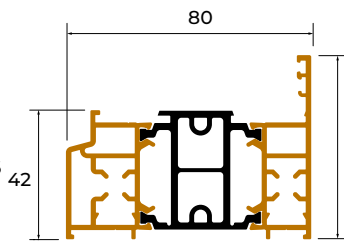

SP103
INTERMEDIATE FLUSH OUTER FRAME

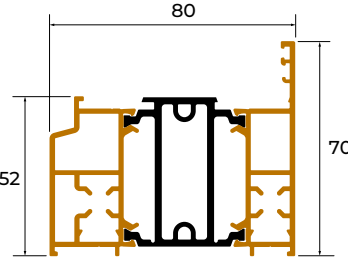

SP105
LARGE FLUSH OUTER FRAME

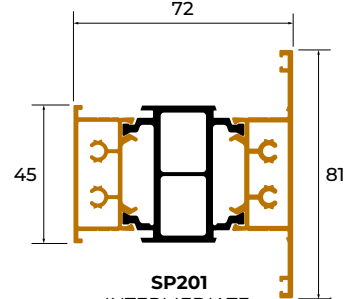

SP201
INTERMEDIATE
TRANSOM/MULLION

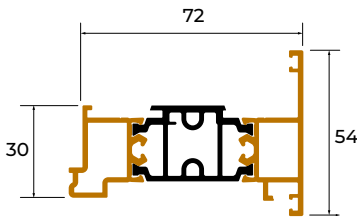

SP250
MEETING STILE

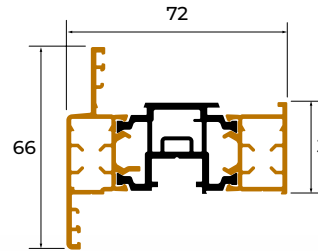

SP301
STEPPED SASH

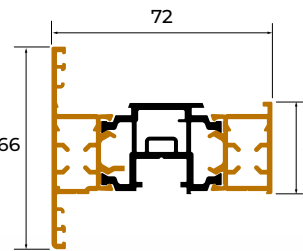

SP301
CONTEMPORARY SASH

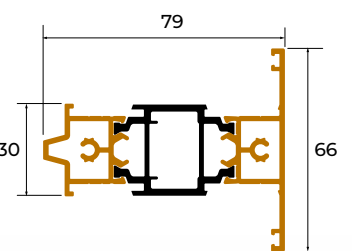

SP210
FLUSH
TRANSOM/MULLION



SP400
28mm CLIP-IN BEAD
(not for stepped sashes)



SP401
28mm SHUFFLE BEAD
(not for stepped sashes)



SP402
36mm CLIP-IN BEAD
(28mm for stepped sashes)



SP403
36mm CLIP-IN BEAD
(28mm for stepped sashes)



SP404
44mm CLIP-IN BEAD
(36mm for stepped sashes)

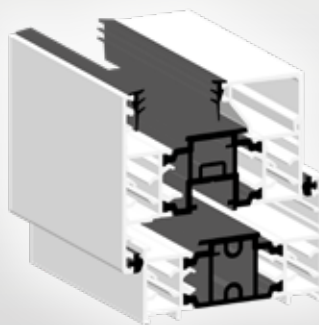

Contemporary sash,
Standard frame

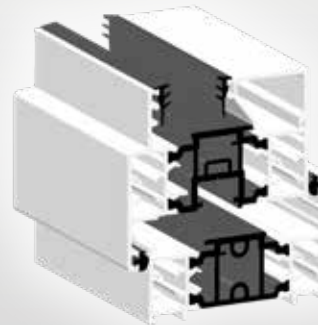

Stepped sash,
Standard frame



Enhancing the features of our popular aluminium product range

We have always strived to develop and improve our product range throughout our 40 year history. Even with the recently introduced Sheerline window, door and roof systems we have still taken a technically-advanced core product and modified and upgraded them for the benefit of our customers.

Developing Prestige[®]

The larger profile of the Prestige[®] range has allowed us to extend the frame options that make for a cleaner, simpler installation.

Prestige[®] outer frame

	Small	Intermediate	Large
Hood vent [Prestige [®]]	✗	✓	✓
Deep frame head [Prestige [®]]	✓	✗	✓
Semi-low threshold [Prestige [®]]	✓	✗	✓
Aluminium trickle vent [Prestige [®] and Classic [®]]	✓	✓	✓
Odd-leg outer frame [Prestige [®]]	✓	✗	✗

window & door updates

new features for classic, prestige and define

Hood Vent

NOTE the hood vent must be fitted before installation of the outer frame

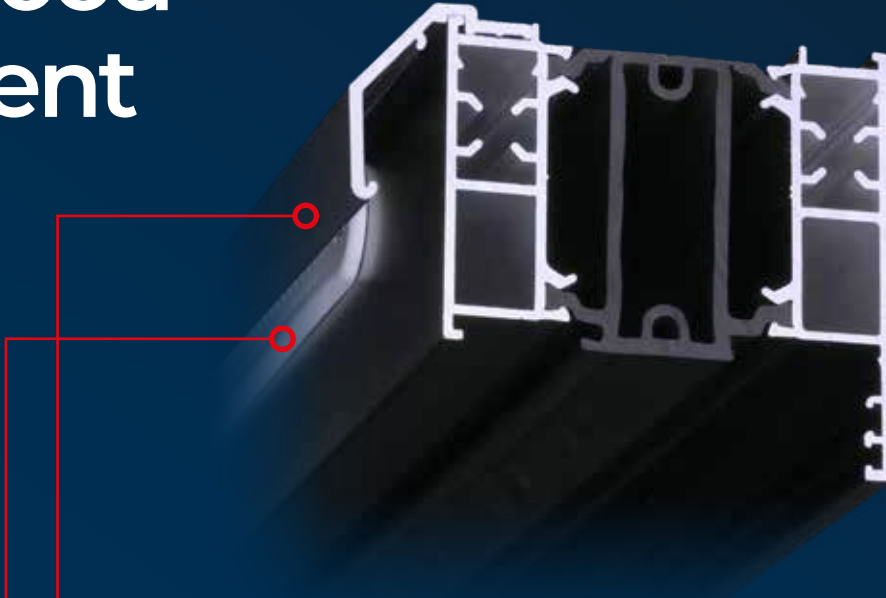

Hood Vent is supplied to the width of the outer frame. It can be oversized to enable on-site cutting for bow / bay windows.



NEW Aluminium Hood Vent

Completely obscures the trickle vent for a sleek, simplified appearance.

'Grille' Trickle Vent

Slimmer, flusher fitting grille offers a more attractive solution for Building Regulations Part F compliance (shown in white for clarity)

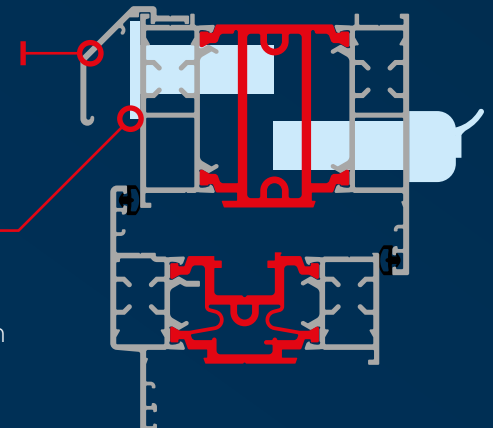

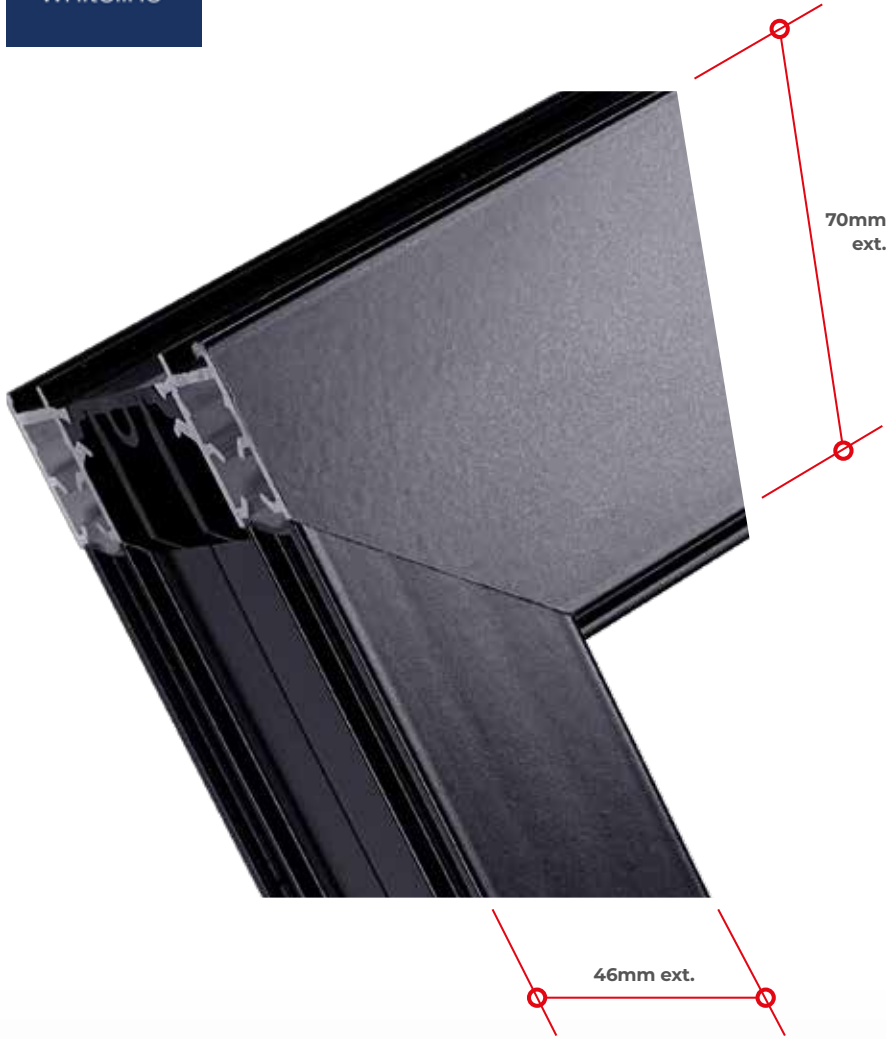

Large Head

Increased head depth for trickle ventilation

Using the deeper 70mm outer frame as a 'head' profile allows much more room for safely installing trickle ventilation within the plaster-line without having to use any 'add-on' profiles.

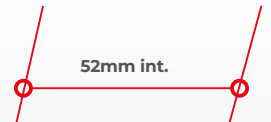

Semi-low Threshold

Low threshold

Colour-coded threshold measuring just 45mm in height.



window & door updates

new features for classic, prestige and define

Odd Leg Frame

Odd leg outer frame

Odd leg windows have an external lip on the frame. This design gives extra protection against adverse weather and is mainly used on properties with narrow wall construction. These buildings are normally externally clad.

This is a particular requirement of motorhomes and static caravans but also suited to fitting aluminium frames into original timber frames for a traditional aesthetic.

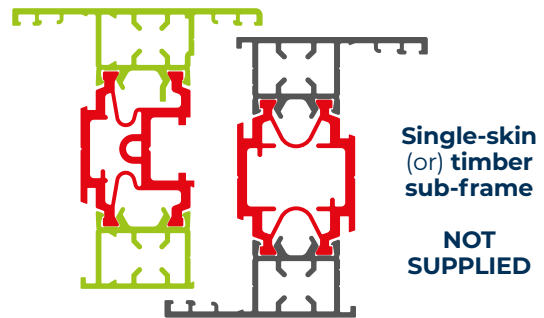

Aluminium Trickle Vent

Elegant, alternative trickle ventilation

A neater and cleaner solution with full Building Regulations compliance.

NOTE only available as a 4000mm³ vent.

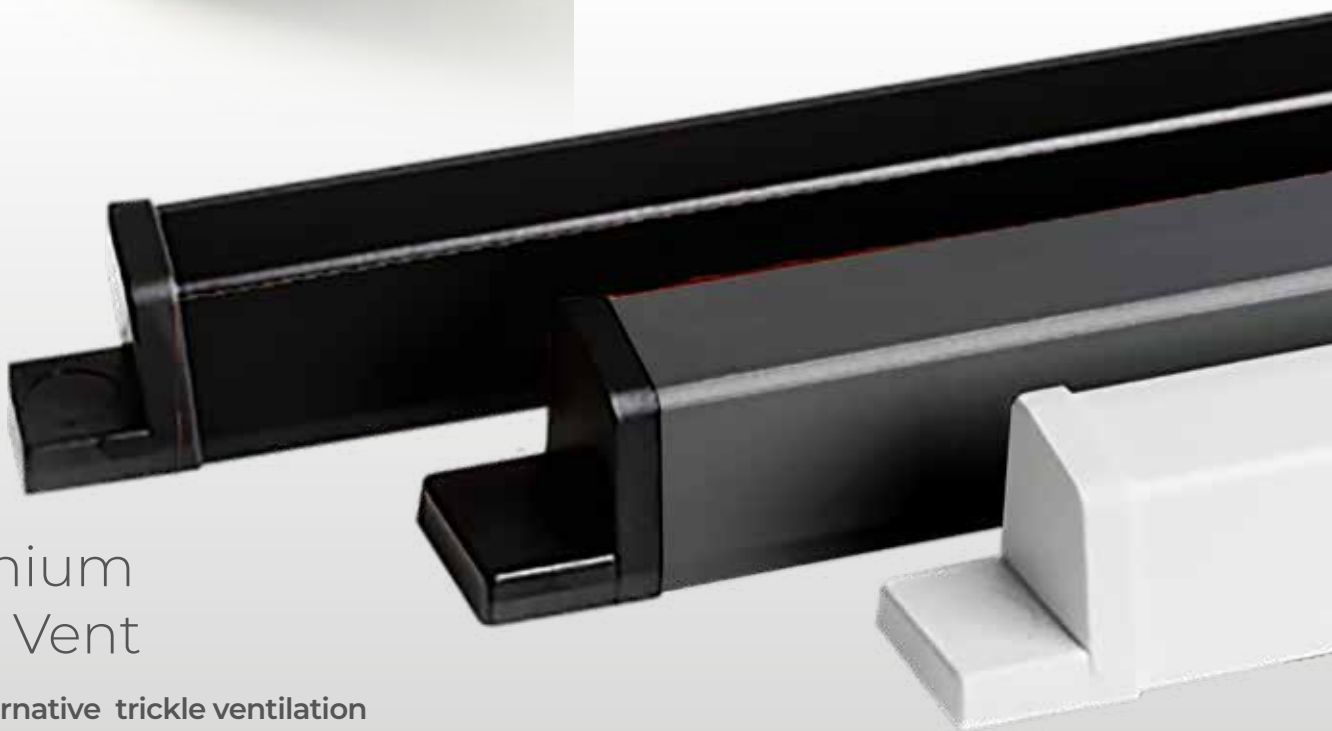



0800 652 3151

info@whiteline.co.uk

whiteline.co.uk

BR0068 Sheerline Brochure 2024 v5.2

All rights reserved © 2024 Whiteline Manufacturing Limited

In our ongoing quest to provide the highest quality products our designs and specifications are subject to change without any notice. Except as allowed by law, no part of this publication may be reproduced in any form without written consent.



whiteline